

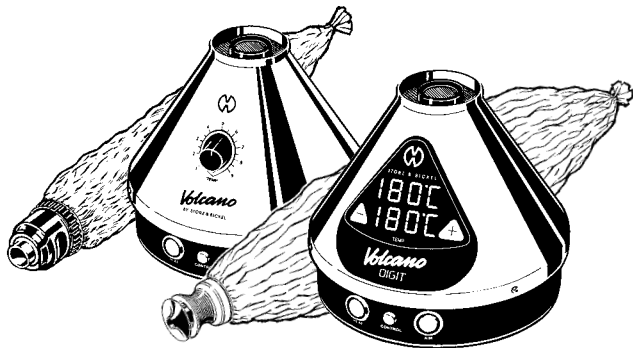

STORZ & BICKEL GMBH & CO. KG



Volcano[®]

VAPORIZATION SYSTEM

INSTRUCTIONS FOR USE

Read carefully before using the device and
save these instructions.

INSTRUCTIONS FOR USE

Table of contents	page
Product overview, Service.....	4
Safety recommendations, Explanation of symbols.....	6
Intended use.....	9
Overview of plants.....	10
Factors influencing vaporization.....	11
The Hot Air Generators	
VOLCANO DIGIT and VOLCANO CLASSIC	12
Unpacking, Installation, Application and operation, Care and maintenance, Storage, In case of problems, Troubleshooting, Technical specifications	
VOLCANO DIGIT	15
Installation, Heating up, Temperature setting	
VOLCANO CLASSIC	17
Installation, Heating up, Temperature setting	
EASY VALVE	
Application and operation.....	18
Cleaning and maintenance.....	21
SOLID VALVE	
Application and operation.....	23
Cleaning and maintenance.....	27
Liquid Pad	32
CE declaration of conformity.....	34
Warranty, Liability, Repair service.....	34

PRODUCT OVERVIEW *SOLID VALVE*

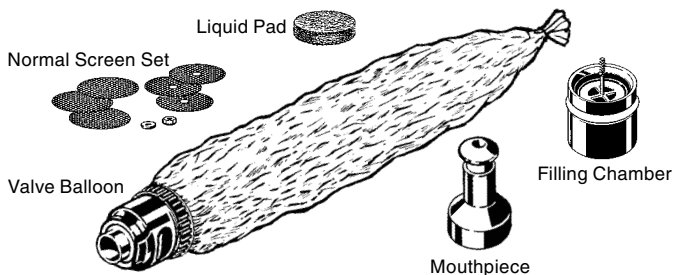

Compatible with **VOLCANO CLASSIC** and **VOLCANO DIGIT**

PRODUCT OVERVIEW *VOLCANO CLASSIC*

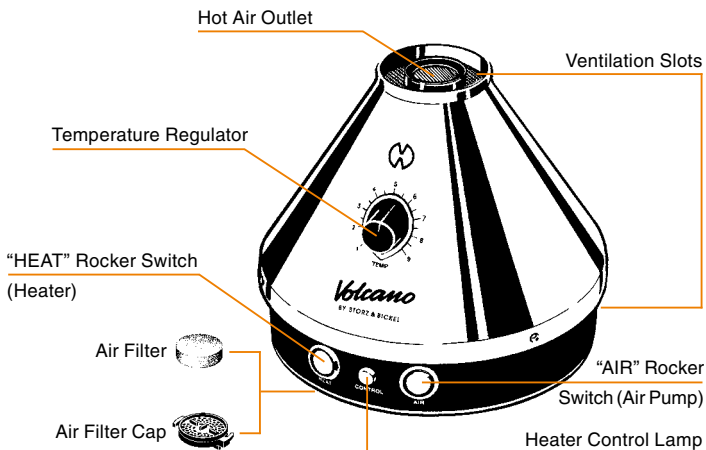

PRODUCT OVERVIEW *EASY VALVE*

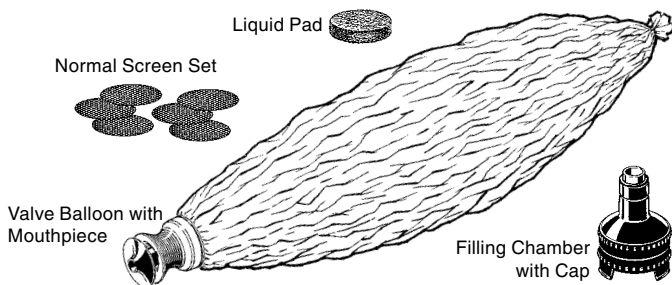

Compatible with ***VOLCANO CLASSIC*** and ***VOLCANO DIGIT***

PRODUCT OVERVIEW *VOLCANO DIGIT*

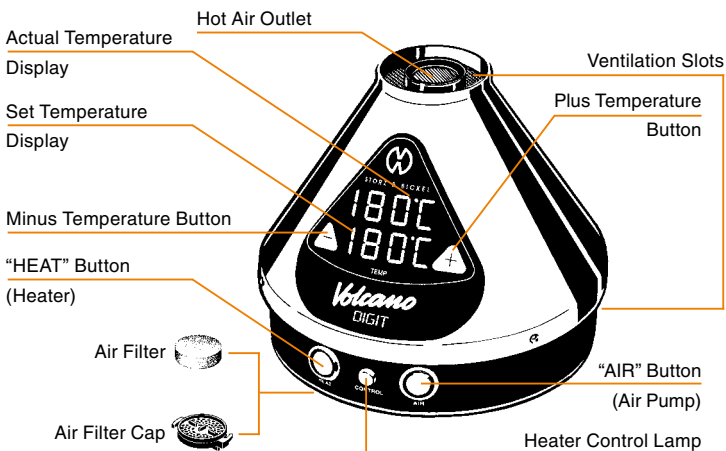

SERVICE, SAFETY RECOMMENDATIONS

Please check whether all components have been included. If not, please inform the Storz & Bickel Service Center.

In the case of technical problems, questions about the device, repairs, warranty claims and disposal of the device, customers in the US and Canada should contact the following address:

Storz & Bickel America, Inc.

1078 60th Street, Suite A • Oakland, CA 94608

Phone: 510-451-1553 • Fax: 510-451-2053

email: service-america@storz-bickel.com

All other customers should contact the following address:

Storz & Bickel GmbH & Co. KG

Rote Strasse 1 • 78532 Tuttlingen, Germany

Phone: +49-74 61-96 97 07-0 • Fax +49-74 61-96 97 07-7

email: service@storz-bickel.com



Read the following safety recommendations thoroughly and carefully before using the device.

These Instructions for Use are a significant part of the *VOLCANO* Vaporization System and must be provided to the user. The instructions given in these Instructions for Use must be strictly observed as

they are extremely important to ensure safety during installation, use and maintenance of the *VOLCANO* Vaporization System.

Please keep this brochure in a safe place for future reference. You may download the current Instructions for Use for the *VOLCANO* Vaporization System on www.storz-bickel.com.

Explanation of symbols



Please follow these instructions carefully!



EU conformity symbol:

The manufacturer confirms with this symbol the compliance of the product with the applicable European directives and standards.



Caution! Hot surfaces!

Never leave Filling Chamber on *VOLCANO* Hot Air Generator.



Safety recommendations!

In order to avoid injuries to persons and damage to the equipment, it is mandatory to observe instructions marked with this symbol.

SAFETY RECOMMENDATIONS

Explanation of symbols



Note/Tip!

This symbol always gives you technical information or useful tips regarding the **VOLCANO** Vaporization System.



Keep away from sunlight.



The device was introduced after 13 August 2005. It may not be disposed of in normal household waste. The X on the trash can indicates the necessity of disposing of this product separately.



Protect against moisture and humidity.



Nationally Recognized Testing Laboratory: Additional requirements of UL 499 and CNA/CSA-C22.2 No. 64 have been tested on the basis of EN 60335-1.



Safety tested and production monitored by TUEV SUED Germany



Symbol for the manufacturer - the manufacturer's name and address are next to the symbol

Safety recommendations

- The packing material (plastic bags, styrofoam material, boxes etc.) must be kept out of the reach of children as it is a potential source of danger.
- People who require assistance must be supervised constantly during application. Such persons often underestimate the hazards involved (e.g. strangulation with the power cord), thus resulting in a risk of injury.
- The device contains small parts which can block the respiratory tract and lead to choking. Therefore, make sure that you always keep the Hot Air Generator and accessories out of the reach of babies and infants.
- Before connecting the Hot Air Generator, make sure that the information given on the type label on the underside of the Hot Air Generator corresponds to the mains supply at the place of installation.

SAFETY RECOMMENDATIONS

- If there are any problems during operation, immediately pull out the power plug from the socket.
- The power cord must be unwound over its entire length (avoid rolling up the power cord and overlapping the cord). It must not be exposed to any impacts and must be kept out of the reach of children. Also, it must not be kept near liquids or sources of heat and must not be damaged. Do not wind the power cable tightly, nor pull it over sharp edges and never crush or kink it. If the power cord is damaged, please contact our Service Center to have it replaced. Never try to repair a power cable yourself!
- The use of multiple sockets and/or extension cables is not recommended. However, if this is absolutely necessary, only products with a quality certificate (such as UL, IMQ, VDE, +S etc.) may be used, provided the specified power exceeds the power required (A = Ampere) by the devices that are connected.
- If you have any concerns, ask a specialist to check whether the electrical system is in accordance with the local safety regulations.
- Install the Hot Air Generator on a stable and dry surface at a sufficient distance from sources of heat (oven, stove, fireplace etc.) and in a place where the ambient temperature cannot drop below +5°C (+41°F). Store the Hot Air Generator in a dry place protected against the effects of weather and out of the reach of children or unqualified persons. It cannot be used in damp locations (such as bathrooms etc.).
- Do not operate the Hot Air Generator close to flammable objects such as curtains, tablecloths, or paper.
- Keep the Hot Air Generator away from pets (e.g. hamsters, mice) and other animals which could damage the insulation of the mains adapter cord.
- The Hot Air Generator may only be repaired by our Service Center. Incorrectly performed repairs without the use of original spare parts can prove dangerous to the user.
- Danger to life when opening the Hot Air Generator as live components and connections are exposed.
- The Hot Air Generator must never be repaired or transported when the power plug is plugged in.
- To pull the power plug from the socket, pull the power plug directly, never pull the power cord.
- The Hot Air Generator must never be operated when the power cord is faulty.
- Do not put any objects into the openings of the device.
- Do not leave the Vaporizer unattended during operation. After use, switch off the heater and the air pump.
- The ventilation slots as well as the hot air outlet of the Hot Air Genera-

SAFETY RECOMMENDATIONS

tor must not be closed, obstructed or blocked while the device is being used, nor while it is cooling down.

Caution! Hot surface!

- When they are hot do not touch the hot air outlet and the Filling Chamber.
 - The Filling Chamber may only be placed on the hot air outlet while filling the Valve Balloon. After filling the Valve Balloon the Filling Chamber must be removed from the Hot Air Generator in order to avoid overheating of the Filling Chamber.
- ### **Caution! Hot surface!**
- Do not put any body parts or objects in the hot air jet.
 - Before cleaning, remove the power cord from the socket. The Hot Air Generator should be cleaned only with a dry cloth - or a damp cloth if absolutely necessary. Never immerse the Hot Air Generator in water or in other liquid, nor clean it with direct jets of water or steam.
 - The Hot Air Generator must not be used in damp or wet conditions.

- Do not expose the Hot Air Generator to rain. Do not use in the bathroom or above water.
- Never touch the Hot Air Generator with wet or damp parts of the body.
- Never put containers containing liquids on the Hot Air Generator.
- Never operate the Hot Air Generator when it is wet or damp. If the Hot Air Generator gets wet, it must be checked by our Service Center for damage to electrical components.
- Do not use in an atmosphere with risk of explosion or ignition.
- Never allow the Vaporizer to be used by children or unqualified persons.
- Only use original Storz & Bickel accessories and spare parts.



The manufacturer is not responsible for any damage or personal injury caused by inappropriate, incorrect or irresponsible use.

INTENDED USE

The **VOLCANO** Vaporization System releases fragrances or aromas from the herbs and other plant materials listed below, or from their extracts (aromatic oils). These aromatic substances are released through vaporization by heated air, and may be exhausted directly into the ambient air, or collected in a Valve Balloon for subsequent inhalation.

The device may only be used with the recommended vaporizing media. The use of other substances can present a health risk.

The **VOLCANO** Vaporization System is not intended for medical/therapeutic purposes.

OVERVIEW OF PLANTS

Below is an overview of the plants that are suitable for vaporization in the **VOLCANO**. The aromas and fragrances from the plant materials listed below may be vaporized.*

Any other use is inappropriate and potentially dangerous.

Information and up to date news about plants suitable for vaporization will be published on www.storz-bickel.com.

Plant name	Botanical name	Portion of the plant used	Temperature setting
Eucalyptus	Eucalyptus globulus	the leaves	1 / 130°C (266°F)
Hops	Humulus lupulus	the cones	3 / 154°C (309°F)
Chamomile	Matriarca chamomilla	the blossoms	6 / 190°C (374°F)
Lavender	Lavandula angustifolia	the blossoms	1 / 130°C (266°F)
Lemon balm	Melissa officinalis	the leaves	2 / 142°C (288°F)
Sage	Salvia officinalis	the leaves	6 / 190°C (374°F)
Thyme	Thymus vulgaris	the herb	6 / 190°C (374°F)

The extracts (aromatic oils) of these plants can be vaporized at up to 130°C (266°F) with the help of the Liquid Pad supplied with the Vaporizer. To do so, please follow the instructions given in chapter "Liquid Pad", page 32.

 **WARNING:** Please consult your doctor or pharmacist if you have any medical concerns. It is possible that some plants may cause allergic reactions for the user. If this occurs, it is urgently recommended to refrain from further use of such plants. Only use the plant parts which are found in this list and

which have been verified according to the regulations of the European or any other pharmacopoeia with regard to genuineness, purity and pathogenic germs. You can purchase such plants or plant parts in pharmacies.*

It is important to observe the following instructions in order to set the **VOLCANO** Vaporization System with the plant material in the best possible way for your personal requirements.

*This statement has not been evaluated by the FDA. The **VOLCANO** Vaporization System is not a medical device and is not intended to diagnose, treat, cure or prevent any disease.

FACTORS INFLUENCING VAPORIZATION

The amount of aromas and fragrances released into the Valve Balloon can be influenced by the following factors:

1. **Quality:** The amount of aromas or fragrances contained in the respective plant material that can be vaporized.
2. **Quantity:** The amount of vaporization material in the Filling Chamber.
3. **Surface:** The finer the plant is ground, the greater the surface and the more aromas and fragrances can be released during the vaporization cycle.
4. **Temperature:** The higher the temperatures, the more aromas and fragrances will be released at once.

Please note: Increasing the temperature should be the last resort, because plant material tastes more toasted when using higher temperature.

Since the plant ingredients are released in a gentle manner, the vaporization cycle may be repeated with the same contents in the Filling Chamber. Depending on the four factors described above, the load of the Filling Chamber may be reused multiple times until the aromas and fragrances are released completely. It is advised to take out the content of the Filling Chamber and grind it once again to increase the surface of the original material. An increased temperature would activate more vapor as well, but has a negative effect on the taste. If no

more vapors are visible at the highest temperature, then the vaporization material is completely exhausted and must be replaced with new material. However, for the best aroma results it is advisable to replace the vaporization material before this point.

It is important to watch the vapor density in the Valve Balloon. A fine, white vapor feels very comfortable when inhaled. As the vapor gets denser the taste can get too strong. A very high intensity (density) of the vapor can lead to irritation of the respiratory passages from the concentration of the aromas and fragrances. In this case, the temperature should be lower, so that the intensity of the vapors is reduced.

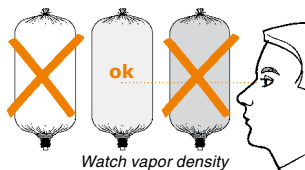

It is not necessary to fill the Valve Balloon completely. It is often sufficient to fill only half or even less than half of the Valve Balloon in order to achieve the desired results.

The Valve Balloon is not suitable for storing vapors over a long period because the vapors condense on the Valve Balloon Jacket over time (a few hours). Only fill the amount you want to inhale within 10 minutes.

FACTORS INFLUENCING VAPORIZATION

Breathing techniques

Inhale only half the amount of air you can normally manage. Hold your breath for a few seconds and then exhale slowly. It is advisable to deliberately concentrate on your breathing process.

For current and detailed information please visit our website:
www.storz-bickel.com

VOLCANO DIGIT AND CLASSIC HOT AIR GENERATORS

Unpacking

The box contains all components as well as the Instructions for Use. Keep the Instructions for Use for future reference.

Take out the Hot Air Generator and the accessories from the box. Immediately after unpacking check whether the Hot Air Generator, the accessories, the power cord and the power plug are all included in the delivery and work properly. If you notice any defects, inform the seller or the delivery agent immediately.



The packing material (plastic bags, styrofoam material, boxes etc.) must be kept out of the reach of children as it is a potential source of danger.

Please dispose of the packing material in a proper and environmentally friendly manner.

We recommend keeping the original packaging in case it is required later (transport, Storz & Bickel Service Center etc.).

Installation

Before installing the Hot Air Generator, make sure that the information given on the type label on the underside of the device corresponds to the local mains supply data. All parts of the electrical system must comply with currently applicable official regulations.

Put the Hot Air Generator on a flat and stable surface.

Take care that the power cord cannot be damaged through kinking, crushing or pulling.



Improper installation may lead to personal injury or material damages, for which the manufacturer cannot be held responsible.

Application and operation



This Hot Air Generator was developed for vaporizing the plant materials listed in the plant overview as well as their extracts. Any other use is inappropriate and potentially dangerous.

For use and maintenance, the user must always follow the instructions given in these Instructions for Use.

VOLCANO DIGIT AND CLASSIC HOT AIR GENERATORS

If you have any concerns, or if there are any problems immediately switch off the Hot Air Generator and pull out the power plug from the socket. Do not try to remedy the defect yourself. Contact our Service Center directly. Allow the device to cool down before it is packed away.

Care and maintenance

Before any maintenance work is done, the device has to be switched off and the power plug has to be unplugged from the power supply.

At the bottom of the Hot Air Generator is an Air Filter. The Air Filter must be inspected for contamination every four weeks by turning the Air Filter Cap counterclockwise and remove the Air Filter.

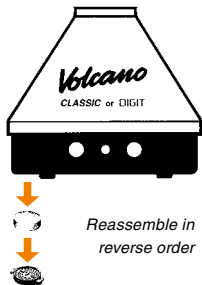

Only clean the device with a damp cloth when dirty. Please do not use any hard or abrasive implements, such as steel wool, metal brushes, needles, inappropriate plastic sponges, etc., nor any aggressive cleaning agents.

Clean the housing with a soft cloth; or, if need be, use a mild cleaning agent (soap water).

Storage

Store the Hot Air Generator in a dry place protected against the effects of weather and out of the reach of children or unqualified persons.

In case of problems

Immediately unplug the power cord and ensure that no one can connect the Hot Air Generator to the mains supply again without this being noticed. If there are any faults in the electronics of **VOLCANO DIGIT**, you can perform a reset by pulling out the power plug and plugging it again after waiting for a minimum of three seconds. Put the Hot Air Generator in the original packaging, or pack it properly in other packing material, and take it to our Service Center.

If the Hot Air Generator is irreparably damaged, please do not simply throw it away. As it is made of high quality, completely recyclable component parts, it should be brought to a material recycling center in your town or sent to our Service Center for disposal.

Troubleshooting

If the device does not function properly when the power plug is connected to the power socket, please check the Hot Air Generator using the tips in the following table:

VOLCANO DIGIT AND CLASSIC HOT AIR GENERATORS

Problem	Possible cause/remedy
No green light signal visible on the display of the VOLCANO ; no activation of the heater or pump possible.	Please make sure that the current is on and that the fuse (in the mains fuse box) is switched on and is not defective. If the Hot Air Generator still does not function, the internal fuses may have been triggered. In this case, send the VOLCANO Hot Air Generator to our Service Center.
No aerosol is formed.	Check the set and actual temperature. Make sure the Filling Chamber and/or Valve Balloon were correctly attached. Check whether an extract (aromatic oil) has been added to the Liquid Pad or whether there is fresh, unused plant material in the Filling Chamber.
The Valve Balloon does not fill up.	Check whether the pump is turned on. Check whether the Filling Chamber and/or Valve Balloon are correctly attached.
The device switches off (automatic switch-off of the VOLCANO DIGIT).	No button was pressed in the last 30 minutes – this leads to automatic switch-off. Switch heater or pump on again.
Plant particles in the Valve Balloon (when using plant material).	Check whether the Screen in the Filling Chamber Cap is clogged or is not inserted into the notch properly. Check whether the Filling Chamber was cleaned according to the Instructions for Use.

VOLCANO DIGIT AND CLASSIC HOT AIR GENERATORS



If the preceding tips do not yield the desired results, or for any other defects or problems not mentioned here, please unplug the power plug and contact our Service Center immediately.



Do not open the Hot Air Generator! Without special tools and specialized knowledge, any attempt to open the device will cause damage to it. Such an attempt will invalidate the warranty claim.

Do not try to remedy the defect yourself. Contact our Service Center directly.

Technical specifications **VOLCANO DIGIT** and **VOLCANO CLASSIC**

Voltage: 220-240 V / 50-60 Hz or 110-120 V / 50-60 Hz.

The voltage specification is located on the bottom side of the **VOLCANO** Hot Air Generator.

Heat output: 100 W

Air pump output: 11 W

Vaporization temperature:

CLASSIC adjustable between approx. 130°C-230°C (266°F-446°F);

DIGIT adjustable between approx. 40°C-230°C (104°F-446°F)

Air flow: approx. 12 l/min

Dimensions: **CLASSIC** and **DIGIT** 20.0 x 18.0 cm (7.9 x 7.1 inch)

Weight:

CLASSIC approx. 1.6 kg (3.5 lbs);

DIGIT approx. 1.8 kg (4.0 lbs)

Safety category I (electrically grounded)

Please unplug to disconnect from the mains current.

Subject to technical changes.

Patents: DE 198 03 376;
DE 100 42 396; EP 0 933 093;
EP 1 884 254; US 6,513,524.

VOLCANO DIGIT

Commissioning



Do not leave the device unattended during operation. Put the **VOLCANO DIGIT** on a flat and stable surface.

Check whether the mains voltage corresponds to the voltage rating stated on the device. The power cord and the power plug must be in perfect condition. Only connect the **VOLCANO DIGIT** to a properly installed (grounded) socket.

It is mandatory to electrically ground the Hot Air Generator. The manufacturer will not bear any responsibility whatsoever if this accident prevention measure is not taken.

When the power plug is plugged in, the LED display of the device lights up briefly. At the same time, an internal software query is performed.

The green dot on the display shows that the Hot Air Generator is connected to the mains supply.

Heating up

To switch on the heater, push the button labeled "HEAT". The set/actual temperature will light up, signaling that the heater is switched on.

At the same time, the yellow control lamp will light up to indicate that the device is heating up.

The upper, red display shows the actual temperature in the Filling Chamber with the air pump switched on, and the lower, green display shows the desired set temperature. The heating process is completed when the set value is equal to the actual value. The heating process can take up to 5 minutes depending upon the chosen temperature. After the heating process is completed, the temperature is constantly maintained at the set value. The luminous intensity of the yellow control lamp corresponds to the intensity of the heating process.

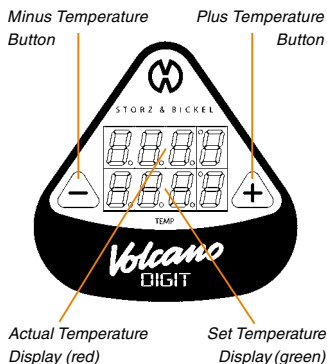

For technical reasons the temperature in the Filling Chamber cannot be measured during vaporization. During operation the temperature is measured at the heat exchanger. The display indicates the reference values for the attached Filling Chamber with the air pump switched on.

Temperature setting

When you press the plus button, the set value is increased, and when you press the minus button, the set value is decreased. When you briefly tap on the plus or minus button, the set values are increased or decreased respectively in 1-degree increments. If you keep the plus or minus button pressed, the set values start running continuously in the corresponding direction. If you simultaneously tap on the plus button and the minus button, the display changes from degree Celsius to degree Fahrenheit and vice versa.



If the actual value is higher than the set value, you can speed up the cool off process by switching on the air pump.



30 minutes after the last time a button is pressed, the device automatically switches off.

As long as the heater has a substantial amount of residual warmth, the temperature is displayed until it drops below +40°C (+104°F). Then the display turns off, and the green dot on the display indicates that the Hot Air Generator is connected to the mains supply.

VOLCANO CLASSIC

Commissioning



Do not leave the device unattended during operation. Put the **VOLCANO CLASSIC** on a flat and stable surface. Check whether the mains voltage corresponds to the voltage rating stated on the device. The power cord and the plug must be in a perfect condition. Only connect the **VOLCANO CLASSIC** to a properly installed (grounded) socket.

It is mandatory to electrically ground the Hot Air Generator. The manufacturer will not bear any responsibility whatsoever if this accident prevention measure is not taken.

Heating up

To switch on the heater, push the rocker switch labeled "HEAT". The rocker switch will light up signaling that the heater is in operation. At the same time, the yellow control lamp will be signaling that the device is heating up. This heating process of the heat exchanger can take up to 5 minutes depending upon the chosen temperature.

As soon as the yellow control lamp turns off, the set temperature has been reached, and the heat exchanger's warming process is complete. If the temperature in the heat exchanger drops, the heat exchanger will automatically heat up, which is signaled by the yellow control lamp lighting up again.

Temperature setting

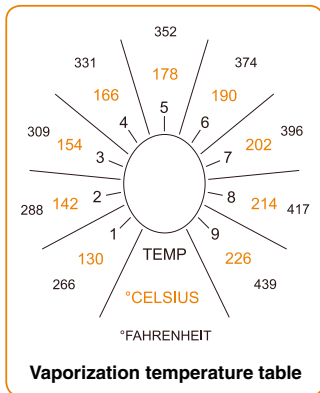

The vaporization temperature may fluctuate about $\pm 5^{\circ}\text{C}$ ($\pm 9^{\circ}\text{F}$) related to the indicated values because of the heating and cool off process of the heat exchanger. For example at level 6 from 185°C up to 195°C (365°F up to 383°F).

Select the desired temperature at the temperature regulator knob.



Select temperature

EASY VALVE APPLICATION AND OPERATION

Turn the Filling Chamber Cap counter-clockwise in order to remove it from the Filling Chamber.

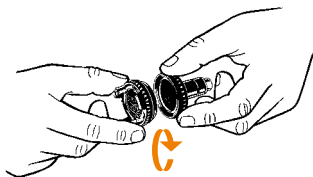

Remove Filling Chamber Cap

Fill the desired amount of ground plant material in the Filling Chamber.

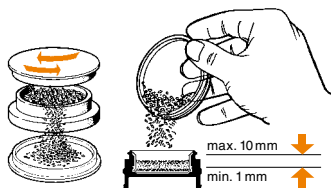

Fill Filling Chamber

Next screw on the Filling Chamber Cap again.



Screw on Filling Chamber Cap

Take care that the Screens are not obstructed with plant material. To guarantee optimal results, we recommend cleaning the Screens after each vaporization cycle with the enclosed Cleaning Brush.

Put the Filling Chamber with Cap on the hot air outlet of the Hot Air Generator and allow it to lock in place. Switch on the air pump. To do so, press the green button/switch labeled "AIR". The Filling Chamber as well as the vaporization material must be preheated for a couple of seconds before the aromas and fragrances start to vaporize. Before attaching, remove the Mouthpiece from the Valve Balloon.

approx. 5 sec



*Preheat plant material
for a few seconds*

Before putting the Valve Balloon on the Filling Chamber, stretch it tight so that the Balloon is placed vertically on the Hot Air Generator when it is filled.

EASY VALVE APPLICATION AND OPERATION

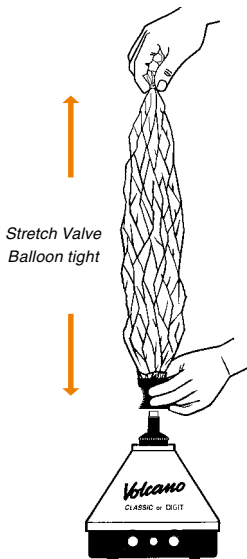

Put the Valve Balloon on the Filling Chamber and allow it to lock in place. This will open the Valve. Now the Valve Balloon will fill with vapors of aromas and fragrances.

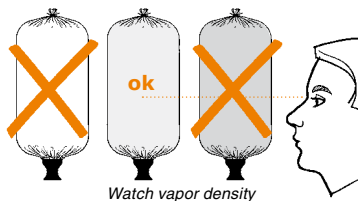

Only fill the Valve Balloon with the approximate amount of vapor that you intend to use within the next 10 minutes. Do not fill the Valve Balloon completely (overpressure) in order to prevent the loss of vapors of aromas and fragrances. It is important to observe the vapor density in the Valve Balloon (see "Factors influencing vaporization", page 11).



When the Valve Balloon is filled, switch off the air pump and remove the Balloon together with the Filling Chamber. To do so, hold the Filling Chamber Cap at the textured grip.



Caution! Hot surface!

-  Do not touch any components of the Filling Chamber (except at the textured grip) until they have cooled down after the Valve Balloon has been filled.
-  Never touch the Filling Chamber (except at the textured grip) until it has cooled down after the Valve Balloon has been filled.

Never leave the Filling Chamber on top of the hot air outlet of the **VOLCANO** as long as the heater is on, except when filling the Valve Balloon. Non-observance can lead to an overheated Filling Chamber, which might burn one's fingers.

EASY VALVE APPLICATION AND OPERATION



Caution! Hot surface!

Never leave Filling Chamber on **VOLCANO**

Detach the Valve Balloon from the Filling Chamber. When you do so, the Valve is automatically closed so that the vapors in the Valve Balloon cannot escape.

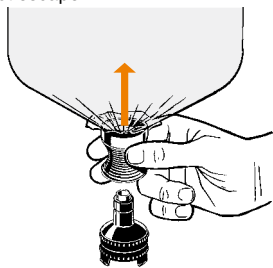

Detach Valve Balloon from Filling Chamber

Attach the Mouthpiece to the Valve and allow it to lock in place.

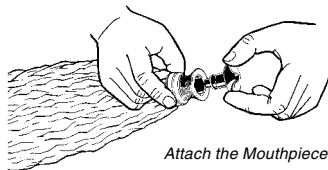

Attach the Mouthpiece
to the Valve Balloon

To inhale, put the Mouthpiece to your lips and press them lightly against the Mouthpiece. By doing so, the Valve opens and the vapors can be inhaled from the Valve Balloon. As soon as you remove the pressure from the Mouthpiece, the Valve automatically closes.

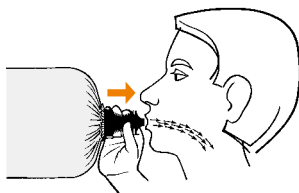

Press Mouthpiece against lips and
inhale slowly and evenly for several seconds

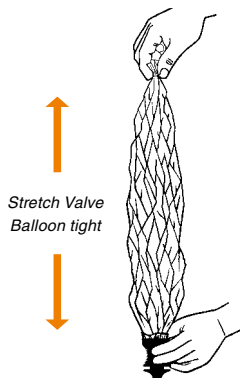

Stretch Valve
Balloon tight

EASY VALVE APPLICATION AND OPERATION



As the content of the Valve Balloon deflates, it may be completely emptied by stretching the Balloon taut and subsequently inhaling the content.

EASY VALVE CLEANING AND MAINTENANCE

EASY VALVE Balloon with Mouthpiece

The **EASY VALVE** Balloon and its Mouthpiece require no maintenance. For hygienic reasons, they should be replaced with a new Valve Balloon and Mouthpiece every two weeks. To prevent any transfer of infectious germs, the Valve Balloon and Mouthpiece should be used only by one person, and never shared by multiple individuals.

Filling Chamber with Filling Chamber Cap

Please allow the Filling Chamber and the Cap to cool down before disassembling them. The component parts of the Filling Chamber must be thoroughly cleaned on a regular basis to guarantee proper operation and pure flavor. For hygienic reasons, it is also necessary to clean the Filling Chamber with Cap for hygienic reasons when the device is to be used by a different person. If a new Valve Balloon and Mouthpiece are used, the Filling Chamber should also be cleaned beforehand. For manual cleaning, use

rubbing alcohol and paper or cotton towels or warm water with wash-up liquid. Filling Chamber and Cap may be easily disassembled and reassembled for cleaning in a few seconds. Filling Chamber and Cap Components may also be cleaned in a dishwasher. However, the Screens, Cap Ring and Filling Chamber Clips are very small, and may be lost if placed in a dishwasher. Before assembling allow all component parts to dry properly.

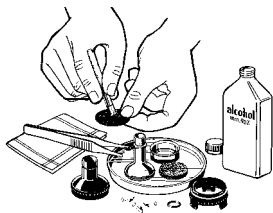

Manual cleaning with alcohol (min. 90%)

EASY VALVE CLEANING AND MAINTENANCE



Do not immerse any plastic components in ethanol or alcohol for longer than an hour. Extended contact with ethanol or alcohol may lead to discoloration or embrittlement of plastic parts.

After cleaning, check all component parts for surface damage, tears, softening or hardening, impurities, distortion and discoloration and set damaged component parts aside.

Disassembling the Filling Chamber Cap

Push the upper Screen downwards, by using (for example) the handle of the Cleaning Brush supplied.

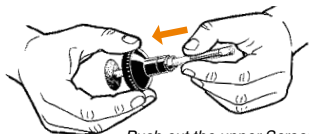

Push out the upper Screen with help of the Cleaning Brush

Push the Cap Cylinder downwards out of the Cap Housing. At the same time the Cap Ring will be stripped off.

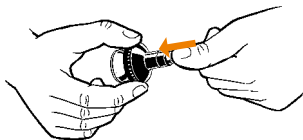

Push the Cap Cylinder out of the Cap Housing

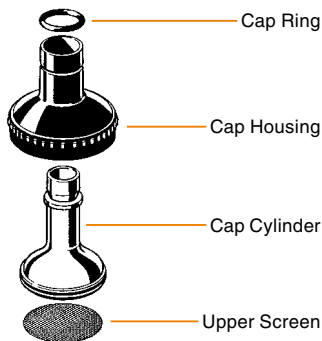

Reassemble in reverse order.



The upper Screen has to be placed carefully into the intended notch. Non-observance may result in plant particles in the Valve Balloon that might be inhaled subsequently.

Disassembling the Filling Chamber

Push the lower Screen or the Liquid Pad upwards out of the Filling Chamber Cylinder. Push the Filling Chamber Cylinder upwards out of the Filling Chamber Housing.

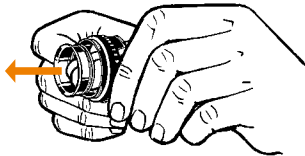

Push the Filling Chamber Cylinder upwards out of the Filling Chamber Housing

EASY VALVE CLEANING AND MAINTENANCE

When the Filling Chamber Cylinder is pushed out, the three Filling Chamber Clips are loosened and fall out of the Filling Chamber Housing.

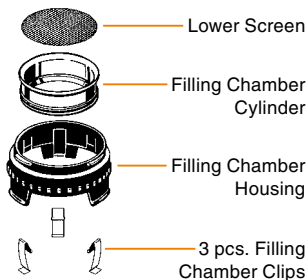

Assembling the Filling Chamber

Push the Filling Chamber Cylinder from above into the Filling Chamber Housing and allow it to lock in place. Insert the Filling Chamber Clips in the openings provided for them in the foot of the Filling Chamber Housing.

Make sure the Filling Chamber Clips are placed properly, as shown in the illustration.

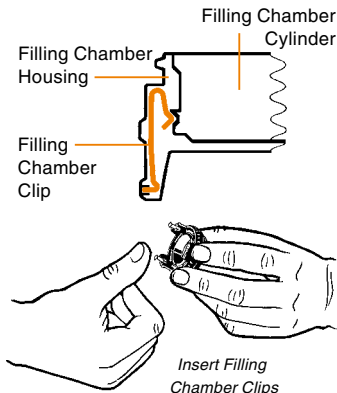

Insert the Screen or the Liquid Pad into the Filling Chamber from above. Screw Filling Chamber Cap on Filling Chamber.

SOLID VALVE APPLICATION AND OPERATION

 The Balloon Material must be kept out of the reach of children as it is a potential source of danger. As an alternative to the **VOLCANO** Balloon, only use heat-resistant, food safe and odor-free oven tubes and oven bags.

Filling the Filling Chamber

Remove the entire Filling Chamber. Insert and fill the Chamber with the desired amount of ground plant material.

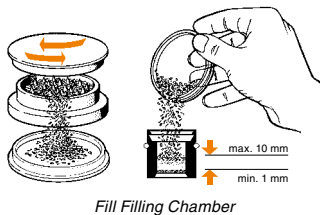

SOLID VALVE APPLICATION AND OPERATION

Fit in the Filling Chamber Insert and use the pin to lower the Screen Unit so that the content of the Filling Chamber is loosely fixed between the Screens.

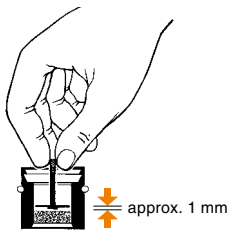

Insert Filling Chamber Insert

Make sure that the Filling Chamber Disc sits properly in the Filling Chamber. It must touch the top edge of the Filling Chamber Cylinder made of stainless steel.

! Take care that the Screens are not obstructed with plant material. To guarantee optimal results, we recommend to clean the Screens after each vaporization cycle with the enclosed Cleaning Brush.

Put the Filling Chamber on the hot air outlet of the Hot Air Generator. Switch on the air pump. To do so, press the green button/switch labeled "AIR". The Filling Chamber as well as the vaporization material must be preheated for a couple of seconds before the aromas and fragrances will start to vaporize.



Preheat plant material for a few seconds

! Before putting the Valve Balloon on the Filling Chamber, stretch it so that it extends vertically from the Hot Air Generator when it is filled.

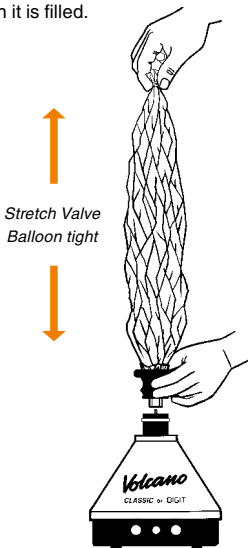

SOLID VALVE APPLICATION AND OPERATION

Attach the Valve with the affixed Balloon to the Filling Chamber. To do this, set the Valve onto the Filling Chamber from above until both grippers are locked in place. The Valve will automatically open up. The Valve Balloon will slowly fill with the vaporized aromas and fragrances.

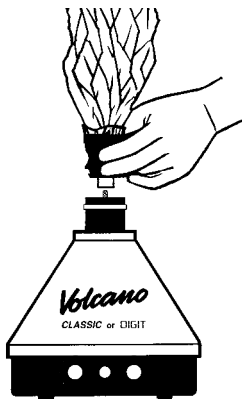

Attach Valve Balloon to Filling Chamber

Only fill the Valve Balloon with the approximate amount of vapor that you intend to use within the next 10 minutes. Do not overfill the Valve Balloon (overpressure) in order to prevent the loss of vapor of aromas and fragrances. It is important to watch the vapor density (as described under "Factors influencing vaporization", page 11).

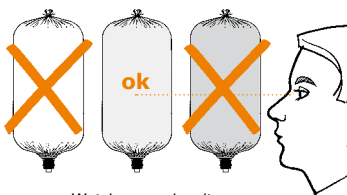

Watch vapor density

When the Valve Balloon is filled, switch off the air pump and remove the Valve Balloon with Filling Chamber. Grasp the Valve firmly with your thumb and index finger at the designated grip indentation.

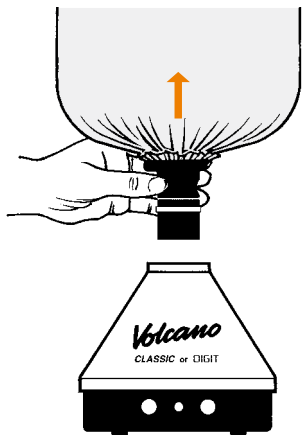

Remove Valve Balloon with Filling Chamber

SOLID VALVE APPLICATION AND OPERATION

Place the Filling Chamber on a heat-proof surface, for example these Instructions for Use, and detach the Valve Balloon from the Filling Chamber by pressing the grippers together. The Valve closes automatically so that the vapors in the Valve Balloon cannot escape.

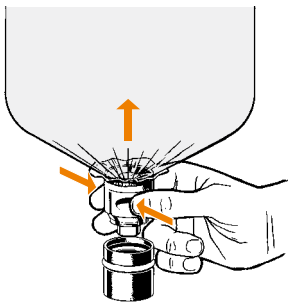

Detach Valve Balloon from Filling Chamber



Caution! Hot surface!

Do not touch any components of the Filling Chamber (except at the textured grip) until they have cooled down after the Valve Balloon has been filled. Do not leave the Filling Chamber on top of the hot air outlet of the **VOLCANO** when "HEAT" is switched on, except for filling the Valve Balloon. Non-observance can lead to an overheated Filling Chamber, which might burn one's fingers.



Caution! Hot surface!

Never leave Filling Chamber on VOLCANO

Attach the Mouthpiece to the Valve Balloon. Make sure that both grippers are locked in place.

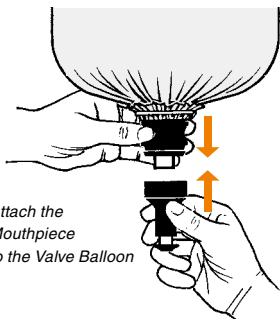

Attach the Mouthpiece to the Valve Balloon

To inhale, put the Mouthpiece to your lips and press them lightly against the Mouthpiece. By doing so, the Valve opens and the vapors can be inhaled from the Valve Balloon. As soon as you remove the pressure from the Mouthpiece, the Valve automatically closes.

SOLID VALVE APPLICATION AND OPERATION

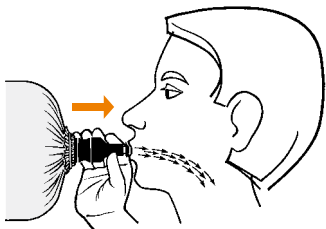

Press Mouthpiece against lips and inhale slowly and evenly for several seconds



As the content of the Valve Balloon deflates, it may be completely emptied by stretching the Balloon taut and subsequently inhaling the content.

Stretch Valve
Balloon tight

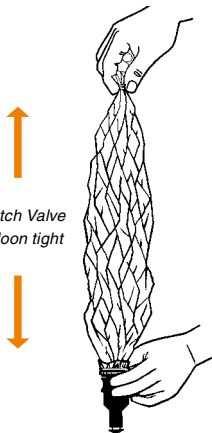

SOLID VALVE CLEANING AND MAINTENANCE

Mouthpiece, Valve and Filling Chamber

For hygienic reasons, the **SOLID VALVE** component parts (Valve Balloon with Mouthpiece and Filling Chamber) should be cleaned at least once every two weeks. To prevent any transfer of infectious germs, the Valve Balloon and Mouthpiece should be used only by one person, and not shared by multiple individuals. The component parts should be cleaned regularly to guarantee proper functioning and a clean taste. For hygienic reasons, a thorough cleaning is required whenever the **SOLID VALVE** is to be used by another individual.

The Balloon should be replaced whenever the Valve is cleaned. For manual cleaning use rubbing alcohol with paper or cotton towels or dish-washing liquid with warm water.

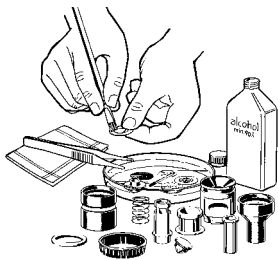

Manual cleaning with alcohol (min. 90%)

SOLID VALVE CLEANING AND MAINTENANCE

The Mouthpiece, Valve and Filling Chamber are easily disassembled within seconds for cleaning. The component parts of the Mouthpiece, Valve and Filling Chamber may also be cleaned in a dishwasher. The Screens and the component parts of the Filling Chamber Insert are too small for that and might get lost in a dishwasher. Before assembling allow all component parts to dry properly.



Do not immerse any plastic components in ethanol or alcohol for longer than an hour.

Extended contact with ethanol or alcohol may lead to discoloration or embrittlement of plastic parts.

After cleaning, check all component parts for surface damage, tears, softening or hardening, impurities, distortion and discoloration and set damaged component parts aside.

Disassembling the Mouthpiece

Pull off the Lip Piece from the Mouthpiece Cylinder and remove the Cylinder from the Mouthpiece Housing.

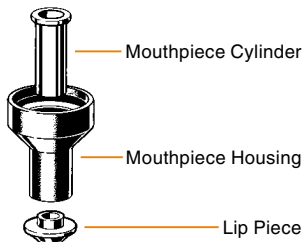
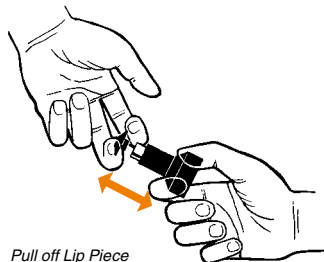

Reassemble in reverse order.

Disassembling the Valve

Undo the Slipping and remove the Valve Balloon along with the Balloon Fixation Ring. Insert your index finger into the open end of the Valve Cylinder. Push up the Valve Cylinder until you can unscrew the Valve Cap.

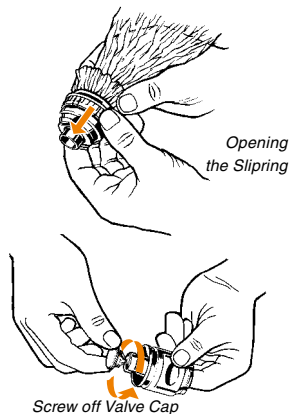

SOLID VALVE CLEANING AND MAINTENANCE

Remove the Valve Cap and Valve Ring. Pull out the Valve Cylinder along with the Valve Spring of the Valve Housing. In case of stiffness, the component parts can be loosened by warming them up in warm water.

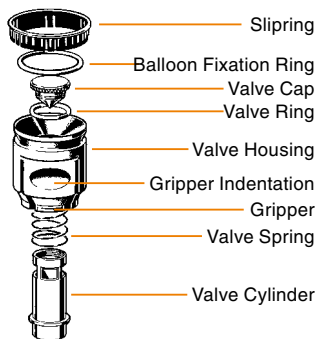

Reassemble in reverse order.

Disassembling the Filling Chamber Insert

The Filling Chamber Insert can be easily removed from the Filling Chamber. The Filling Chamber Insert can be disassembled by screwing off the hex nut.

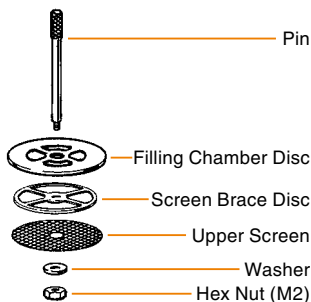

Reassemble in reverse order.

Disassembling the Filling Chamber

The lower Screen will be pushed out of the Filling Chamber. The Filling Chamber Ring can be pulled off with tweezers.

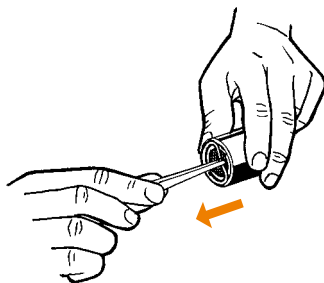

Pull off Filling Chamber Ring with tweezers

SOLID VALVE CLEANING AND MAINTENANCE

Filling Chamber Housing and Filling Chamber Cylinder can be screwed off now. In case of stiffness, the component parts can be loosened by warming them up in warm water.

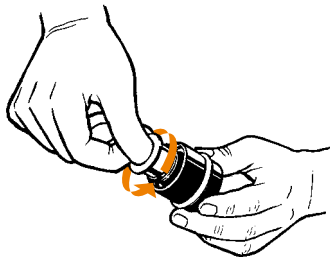

Screw off Filling Chamber Housing from Filling Chamber Cylinder

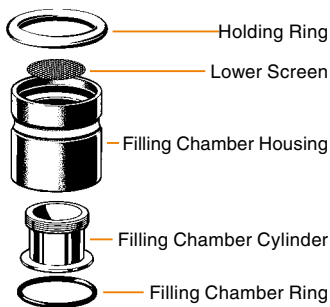

Reassemble in reverse order.

Attachment of the Balloon to the Valve

As an alternative to the **VOLCANO** Balloon, use an odor-free, heat-resistant and food safe oven tube or oven bag, which is used in the food industry. It is available in nearly every drug store and supermarket. Do not use any other plastic bags or clingwraps. The procedure to change a Balloon with a heatproof oven tube is described below:

Cut a piece of approx. 50-60 cm (19-23 inch) and tie it close at one end.

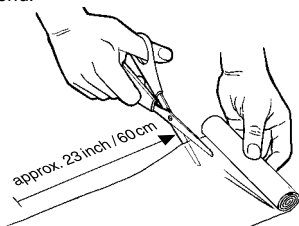

Cut a piece of approx. 50-60 cm (19-23 inch)

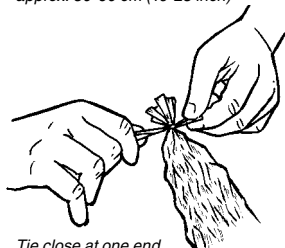

Tie close at one end

SOLID VALVE CLEANING AND MAINTENANCE

As the opening of the Balloon is much wider than the diameter of the Valve Housing, the Balloon must be folded. To do this pull the Balloon Fixation Ring approximately 3 cm (1.2 inch) over the open end of the Balloon and then pull the Balloon Fixation Ring with the Balloon over the Valve Collar until it fits into the intended notch.



Attach Balloon to Valve

Adjust the folds equally around the Valve Collar making certain that the Valve hangs straight down when the Balloon is held at the end.

Bend the protruding end of the Balloon back. Secure the Balloon by pulling the Slipping over both the Valve and the Balloon Fixation Ring so that the Balloon Fixation Ring is no longer visible and the protruding end of the Balloon points backwards.

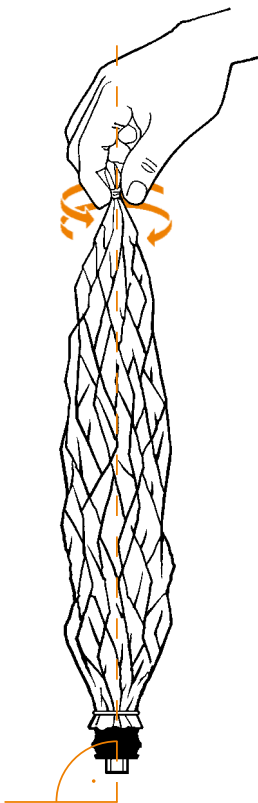

Align Valve Balloon to Valve

SOLID VALVE CLEANING AND MAINTENANCE

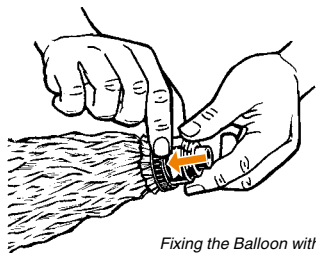

*Fixing the Balloon with
the Slipping*

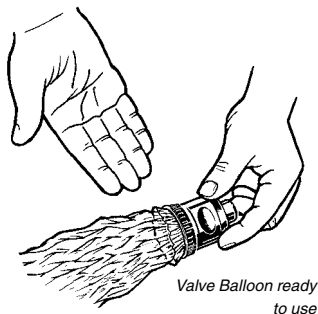

*Valve Balloon ready
to use*

If needed, the extending collar can be trimmed away using a pair of scissors, making certain not to poke a hole into the Balloon.



Balloon Sets may be ordered from **www.storz-bickel.com**.

LIQUID PAD

The Liquid Pad is used to vaporize the extracts (aromatic oils) of the plants specified in the plant list. The stainless steel wire of the Liquid Pad serves as the carrier of the extract, comparable to the unvaporizable plant fibers in vaporization plant material.



Caution! The extracts are usually concentrates; therefore, a very small dosage is sufficient. The vaporized concentrates may not be inhaled directly, but instead pumping them into the room air directly from the Filling Chamber without the Valve Balloon attached.

Preparation

If the Liquid Pad is used, the Screens in the Filling Chamber are not required and should be removed. This applies to the Filling Chamber of the **EASY VALVE** as well as to the Filling Chamber of the **SOLID VALVE**. In both cases the Liquid Pad is inserted in place of the lower Screen in the Filling Chamber. You will need the Filling Chamber Disc of the Filling Chamber Insert of the **SOLID VALVE** as this Valve cannot open without the Filling Chamber Disc.

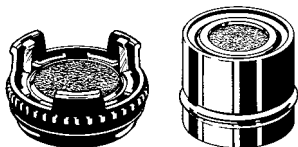

Preparation to use the Liquid Pad

Application

Turn the Filling Chamber upside down and use a pipette to drop the extract onto the center of the bottom of the Liquid Pad. The Liquid Pad can hold up to 10 drops. If you use an extract with unknown concentration, use maximum one drop and carefully increase the amount until you achieve the correct dosage.



*Applying drops
with a pipette*

 Please note that oils become more liquid at high temperatures. If you use too many drops, the extract could drip into the Hot Air Generator, which must be avoided.

Certain extracts may be provided in a diluted form as alcoholic solutions. The advantage of such extracts is that the liquid is distributed more evenly around the stainless steel wire of the Liquid Pad. Therefore, the surface used for vaporization is larger. However, if such extracts are used, first the alcohol must be separated from the extract as alcohol should not be inhaled. To do this, put the Filling Chamber onto the unheated (room temperature) **VOLCANO** and switch on the air pump until the alcohol has evaporated, which may take a few seconds. As alcohol has a characteristic odor, a simple smell test can be performed to find out whether the Filling Chamber is free of

LIQUID PAD

alcohol. The extracts that vaporize only at higher temperatures remain in the Liquid Pad. Then heat up the **VOLCANO** and vaporize the extract left on the Liquid Pad as described in the chapters **EASY VALVE** and **SOLID VALVE**, (pages 18 and 23). Extracts without solvents can be vaporized di-

rectly after they are applied to the Liquid Pad.

Cleaning

Put the Liquid Pad in rubbing alcohol and rinse it thoroughly. As the Liquid Pad is made of stainless steel, it can be used again and again if it is cleaned well.

CE DECLARATION OF CONFORMITY

The devices comply with the following EC Directives:

- Low Voltage Directive 73/23/EWG
- Electromagnetic Compatibility 89/336/EWG

WARRANTY, LIABILITY, REPAIR SERVICE

Manufacturer's representations and warranties

These representations and warranties are applicable to all end-customers (the "Customers" and each, individually, a "Customer") purchasing products (the "Products") sold by Storz & Bickel GmbH & Co. KG or Storz & Bickel America, Inc. (the "Company").

Warranty and limitations

Company warrants solely to the original purchaser of the Products that for the warranty period (as defined below), the Products will be free from defects in materials and workmanship under normal use, and will conform to Company's published specifications of the Products. Notwithstanding the foregoing, Company retains its right

to deviate from its published specifications due to the latest innovations and improvements in function and design of the Products. The foregoing warranty is subject to the proper storage, transportation and use of the Products, and does not include defects due to normal wear and tear or deterioration, including, but not limited to, defects in Screens, Air Filters, Balloon Material, Valve Balloons and similar parts subject to wear and tear.

Upon delivery, Customer shall immediately inspect the Products for conformity and visible defects. Customer shall give Company immediate written notice of any non-conformities or visible defects regarding the Products and contact Company in writing concerning return or repair, as the case may be.

Warranty

Customer shall notify Company in writing of any defects of the Products. Company's sole obligation under the foregoing warranty is, at Company's option, to repair or correct any such covered defect or to replace or exchange the Product, provided Customer has returned the Products with a copy of the original invoice to the Company or one of its authorized repair shops at his own cost. Any repaired, corrected, replaced or exchanged Product shall be subject to the warranty set forth in section "Warranty and limitations", following their repair, correction, replacement or exchange. If Company has received notification from Customer, and no defects of the Product could be discovered, Customer shall bear the costs that Company incurred as a result of the notice.

The warranty period begins on the date when the Products are physically delivered to the Customer's site, and is valid for thirty six (36) months for **VOLCANO DIGIT**, **VOLCANO CLASSIC**, **SOLID VALVE** and **EASY VALVE** Filling Chamber.

Company does not authorize any person or party to assume or create for it any other obligation or liability in connection with the Products except as set forth herein.

All requests and notices from U.S. and Canadian Customers under this warranty shall be directed to:

Storz & Bickel America, Inc.

1078 60th Street, Suite A

Oakland, CA 94608

Phone: 510-451-1553

Fax: 510-451-2053

email:

service-america@storz-bickel.com

All requests and notices from all other Customers under this warranty shall be directed to:

Storz & Bickel GmbH & Co. KG

Rote Strasse 1

78532 Tuttlingen, Germany

Phone +49-74 61-96 97 07-0

Fax +49-74 61-96 97 07-7

email: info@storz-bickel.com

The warranty set forth in section "Warranty and limitations" is made in lieu of all other warranties (whether express or implied), rights or conditions, and Customer acknowledges that except for such limited warranty, the Products are provided "as is." Company specifically disclaims, without limitation, all other warranties, express or implied, of any kind, including, without limitation, the implied warranties of merchantability and fitness for a particular purpose, non-infringement, and those warranties arising from a course of performance, a course of dealing or trade usage.

Liability

Handling of these Products is to be as stated in the Instructions for Use. The user accepts full liability for improper handling and usage of these Products. The intended application only refers to the plants or aromatic

oils named by us. Repair of this Product is only to be done by us or one of our authorized customer services. Only original Storz & Bickel parts are to be used. Failure to comply with any of the points mentioned in these Instructions for Use release Storz & Bickel GmbH & Co. KG from any and all liability.

Limitation of liability

In no event shall Company be liable for any indirect, incidental, punitive, special or consequential damages, including but not limited to, damages for loss of profits, revenue, goodwill or use, incurred by Customer or any third party, whether in an action in contract, tort, strict liability, or imposed by statute, or otherwise, even if advised of the possibility of such damages. Company's liability for damages arising out of or in connection with this agreement shall in no event exceed the purchase price of the Products. It is agreed and acknowledged that the provisions of this agreement allocate the risks between Company and Customer, that Company's pricing reflects this allocation of risk, and but for this allocation and limitation of liability, Company would not have entered into this agreement.

In jurisdictions that limit the scope of or preclude limitations or exclusion of remedies or damages, or of liability, such as liability for gross negligence or willful misconduct or do not allow implied warranties to be excluded, the limitation or exclusion of warranties, remedies, damages or liability

set forth above are intended to apply to the maximum extent permitted by applicable law. Customer may also have other rights that vary by state, country or other jurisdiction.

The information contained in these Instructions for Use are based on our experience and is current and complete to the best of our knowledge and ability at the time of printing. Storz & Bickel GmbH & Co. KG does not accept responsibility for errors, omissions or incorrect interpretations of the contents or any information herein. Users are advised that all applications and uses of the Products described must conform to applicable local laws, ordinances and codes and users of the Products are advised that they are solely responsible for determining and assuring the suitability of any Product for the intended application.

Repair service

After the warranty period has expired, or if there are any defects which are not covered under warranty, our service department will repair the defect after providing the Customer with an estimate and receiving the payment.

Copyright

No part of this document may be reproduced in any form (by printing, photocopying or other means) or processed, duplicated or circulated electronically without the prior written approval of Storz & Bickel GmbH & Co. KG.



www.storz-bickel.com

STORZ & BICKEL GMBH & CO. KG

Rote Strasse 1 · 78532 Tuttlingen/Germany

Tel. +49-7461-969707-0 · Fax +49-7461-969707-7

eMail: info@storz-bickel.com

STORZ & BICKEL AMERICA, INC.

1078 60th Street, Suite A · Oakland, CA 94608, USA

phone: 510-451-1553 · fax: 510-451-2053

eMail: america@storz-bickel.com

